

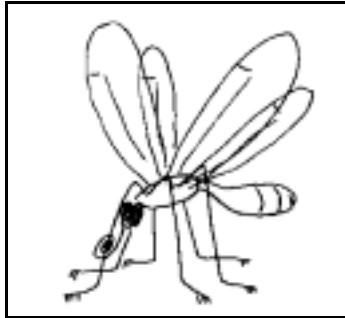

que qui

qu

Qu



mosquito



máquina

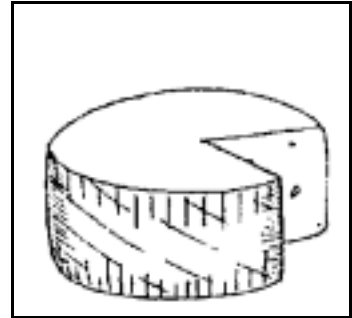

queso

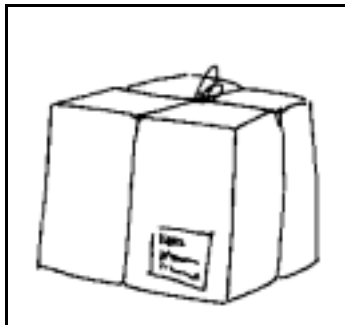

paquete



esquimal



quimono



Quique

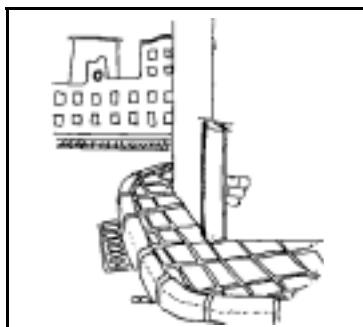

esquina



equipo

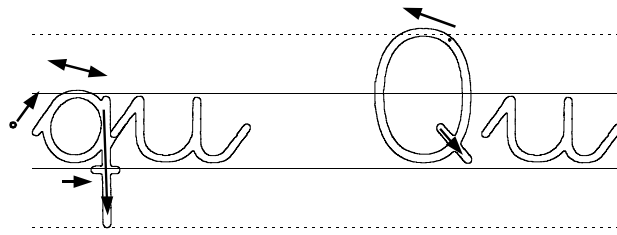

que qui

Que Qui

que qui que

Que Qui Que

paquete queso equipo esquima

Quique esquimal máquina

mosquito quimono

Un paquete de queso

El equipo de tenis

Quique tiene un quimono

El cuento es de esquimales

El mosquito me pica en el

dedo



Que Qui

que qui

El mosquito pica a Quique

El esquimal se pone el quimono

La máquina se cae al suelo

Como queso con pan

Me caí en la esquina

Cuenta con el equipo

El oso pasea con el esquimal

¿En qué piensas?



¿En qué piensas?

Pienso que me duele el dedo

¿Te picó el mosquito?

Sí, me picó en el dedo

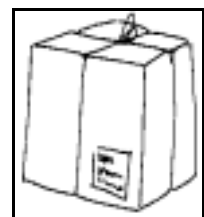
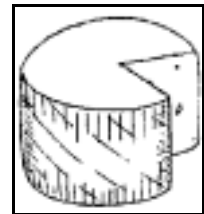
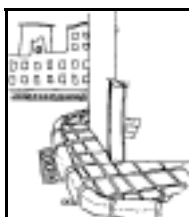
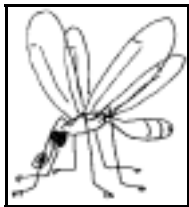

el queso
 el mosquito
 la máquina
 el paquete
 el esquimal
 el quimono
 Quique
 el equipo
 la esquina

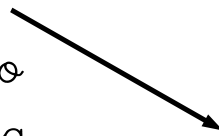



equipo



esquimal



máquina

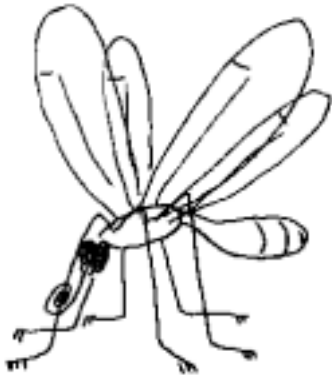

mosquito

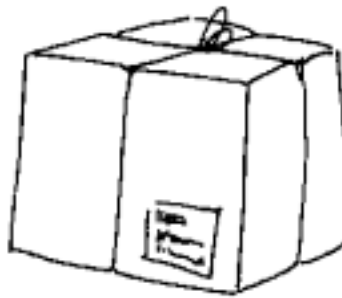

paquete

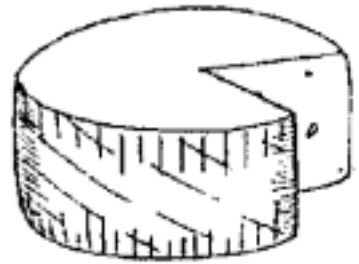

queso



químono



Quique



esquí

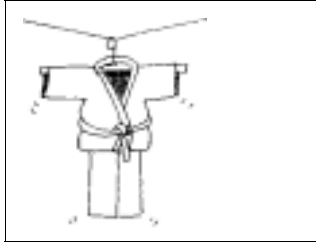

Quique cuida su kimono

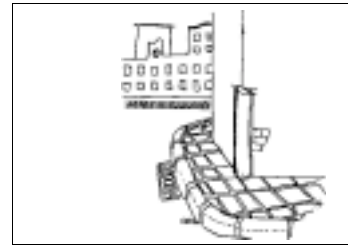

El camión pasa la esquina



El equipo de Quique

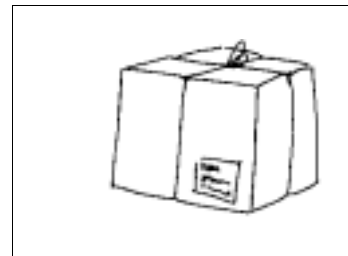

El paquete tiene un queso



mi - tus

mi diente
 _____ copas
 _____ camisa
 _____ pescado
 _____ canoas
 _____ cuentos

tus palas
 _____ cama
 _____ paquetes
 _____ comidas
 _____ quimono
 _____ escuela

~~melocotones~~ camisas médicos cacahuetes
 casas quesos quimonos patatas cuentos

hoy como ...
melocotones





Lee...

El paquete de
Quique

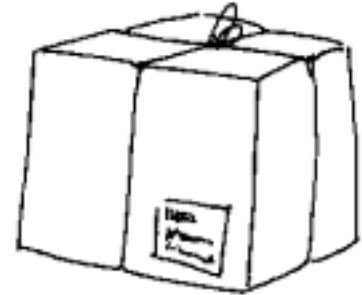

Toma, Quique,
un paquete
¿Qué es?

¿Un queso?
No, no

¿Un quimono?
No, no

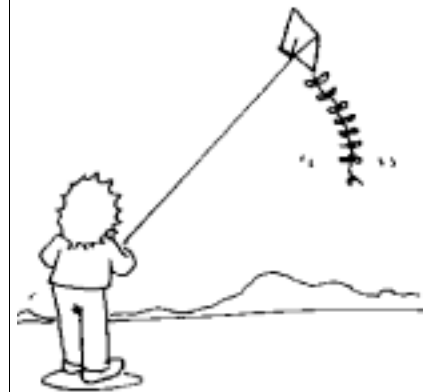
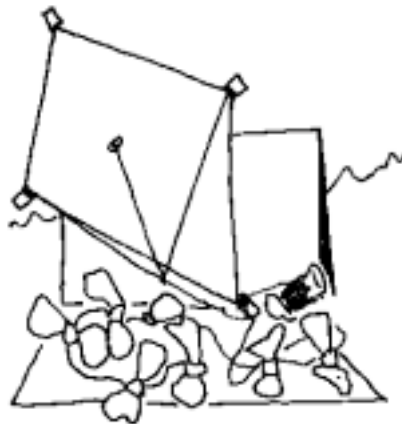

¿Una
máquina?
No, no

¡Es una cometa!

Quique sale con
su cometa

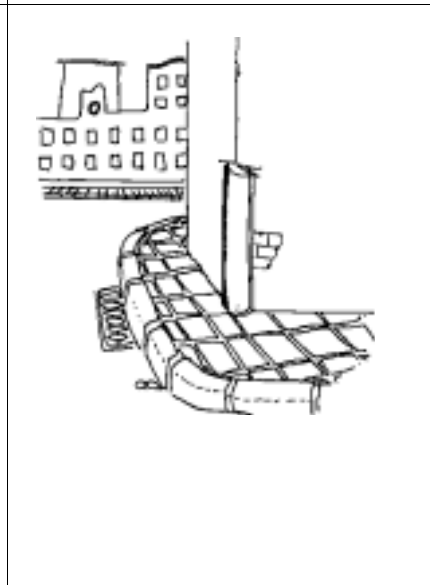
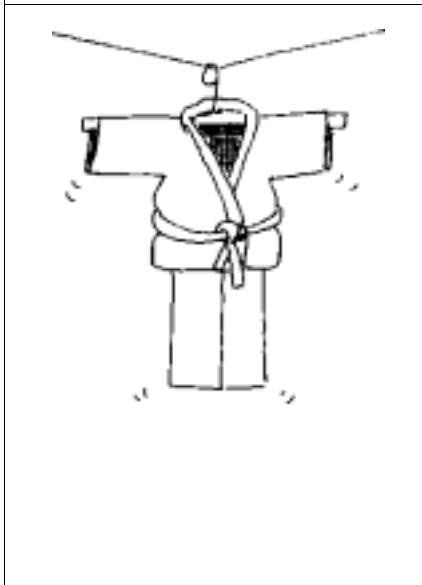
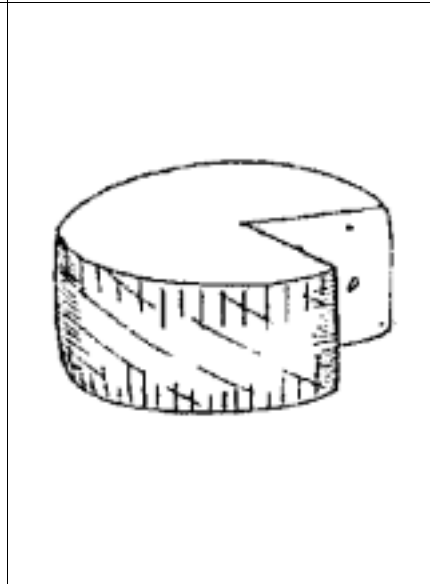
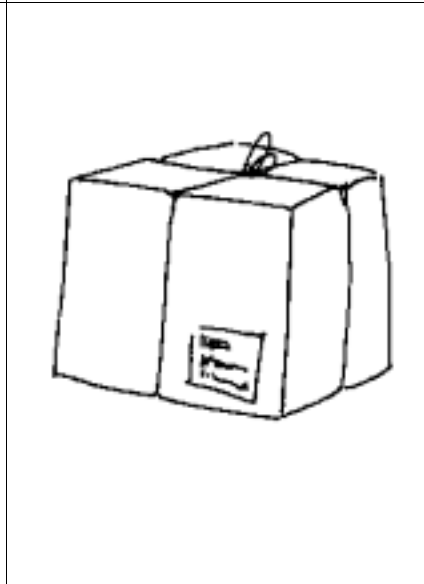
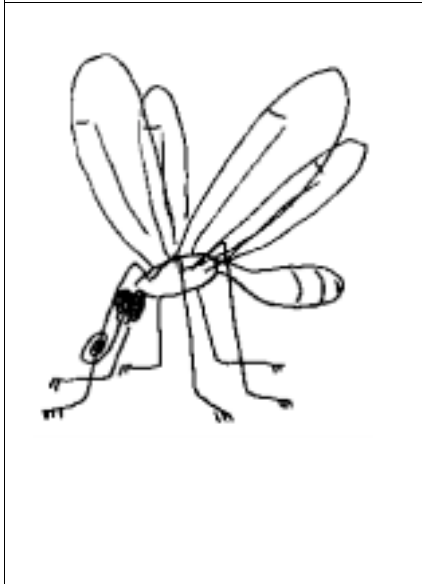



Quique tiene una



Hua seca el





come pan con



La  es de Hu y de Sam

Emi pasa la



de su





Tema 12	第十二课	Unit 12
El paquete de Quique.	奇盖的包裹	Quique's package
Toma, Quique, un paquete. ¿Qué es?	奇盖，拿着，包裹。是什么	Here you are, Quique. A package. What is it?
¿Un queso? No, no.	奶酪？不是，不是。	Is it a cheese? no
¿Un kimono? No, no.	和服？不是，不是。	Is it a kimono? no
¿Una máquina? No, no.	机器？不是，不是。	Is it a machine? no
¡Es una cometa!	是个风筝！	It is a kittle!
Quique sale con su cometa.	奇盖拿着风筝出去了。	Quique goes out with his kittle



Natalia tiene un patito.	纳塔丽娅有个小鸭。	Natalia has a little duck
Asia se alisa el pelo con el peine.	阿西娅用梳子把头发梳直。	Asia smooths her hair with the comb
Pepe tiene un mono con kimono.	贝贝有一个穿和服的猴子。	Pepe has a monkey with a kimono
Luis pone un quitasol en la casa.	路易斯在家里放了一把遮阳	Luis puts an awning in the house
Quique come cacahuets con pan.	奇盖吃花生和面包。	Quique eats some peanuts with bread
El médico le pone pomada en el dedo malo.	医生在他的病指上涂上药	The doctor puts ointment in his bad finger
El saco tiene cocos y patatas.	麻袋里有椰子和土豆。	The sack has some coconuts and potatoes
El esquimal espía al oso.	爱斯基摩人监视着熊。	The skimo stalks the bear